



Zoek je een stevige pagodetent? Kies dan voor de TT84! Deze pagode is standaard uitgevoerd met PVC zeildoeken, maar is uit te breiden met hard wanden of glaswanden. Koppel de TT84 gemakkelijk aan andere pagodes en aluhallen voor meer ruimte.

De robuuste constructie maakt de TT84 geschikt voor baruitgifte of het bevestigen van een bannerframe. Met de banners kun je de tent aanpassen aan de stijl van het evenement. Neem contact met ons op en bestel de TT84 vandaag nog!



Dit tenttype wordt **veel gebruikt** voor:



Beurzen & conferenties



Evenementen



Horeca



Festivals



Bruiloften

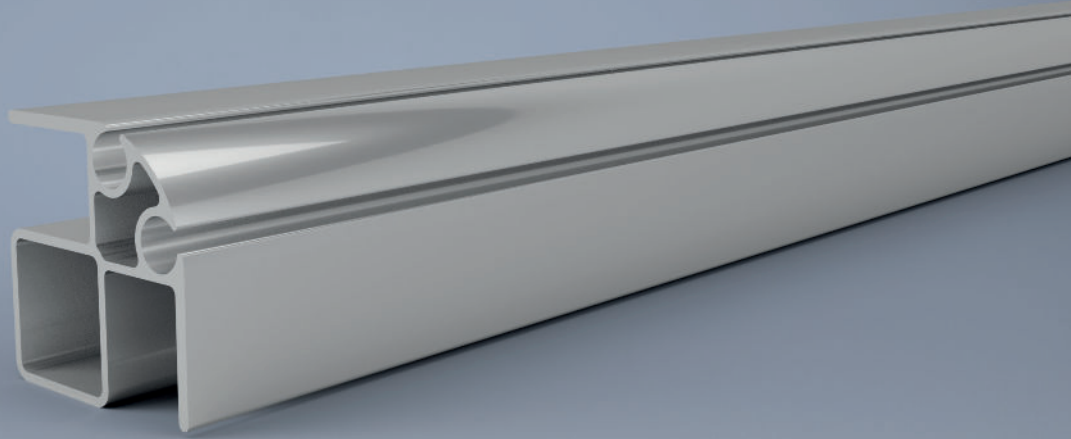

## Algemene specificaties

<b>Formaten:</b>	3,00 x 3,00 m   4,00 x 4,00 m   5,00 x 5,00 m
<b>Zijhoogte:</b>	2,30 m   3,00 m
<b>Nokhoogte</b>	4,08 m - 5,04 m
<b>Dakbekleding</b>	PVC zeildoek lichtdoorlatend   PVC zeildoek verduisterend
<b>Gevelbekleding:</b>	PVC zeildoek lichtdoorlatend   PVC zeildoek verduisterend
<b>Profielmaat</b>	84 x 84 mm
<b>Maximale windlast:</b>	Op aanvraag
<b>Maximale sneeuwlast:</b>	Op aanvraag
<b>Aluminium</b>	AL6082 en AL6005 Natureel geanodiseerd Zeer slijtvast Hoge corrosieweerstand

### Aanvullende opties:

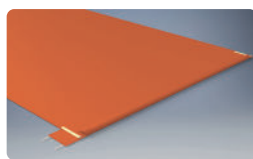

PVC zeildoek in kleur

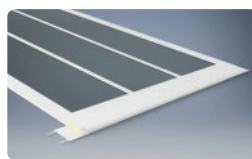

PVC zeildoek transparant

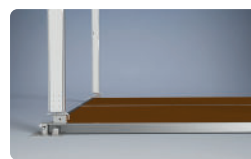

Zwaarlastvloer

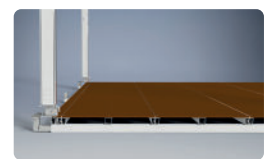

Cassettevloer



Transportbok



Harde wanden



Glazen wanden



Enkele loopdeur



Dubbele loopdeur glas

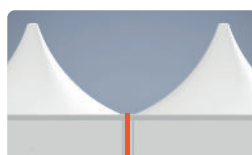

Koppelgoot tussen pagodes

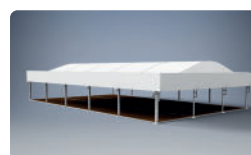

Bannerframes



Bar uitgifte

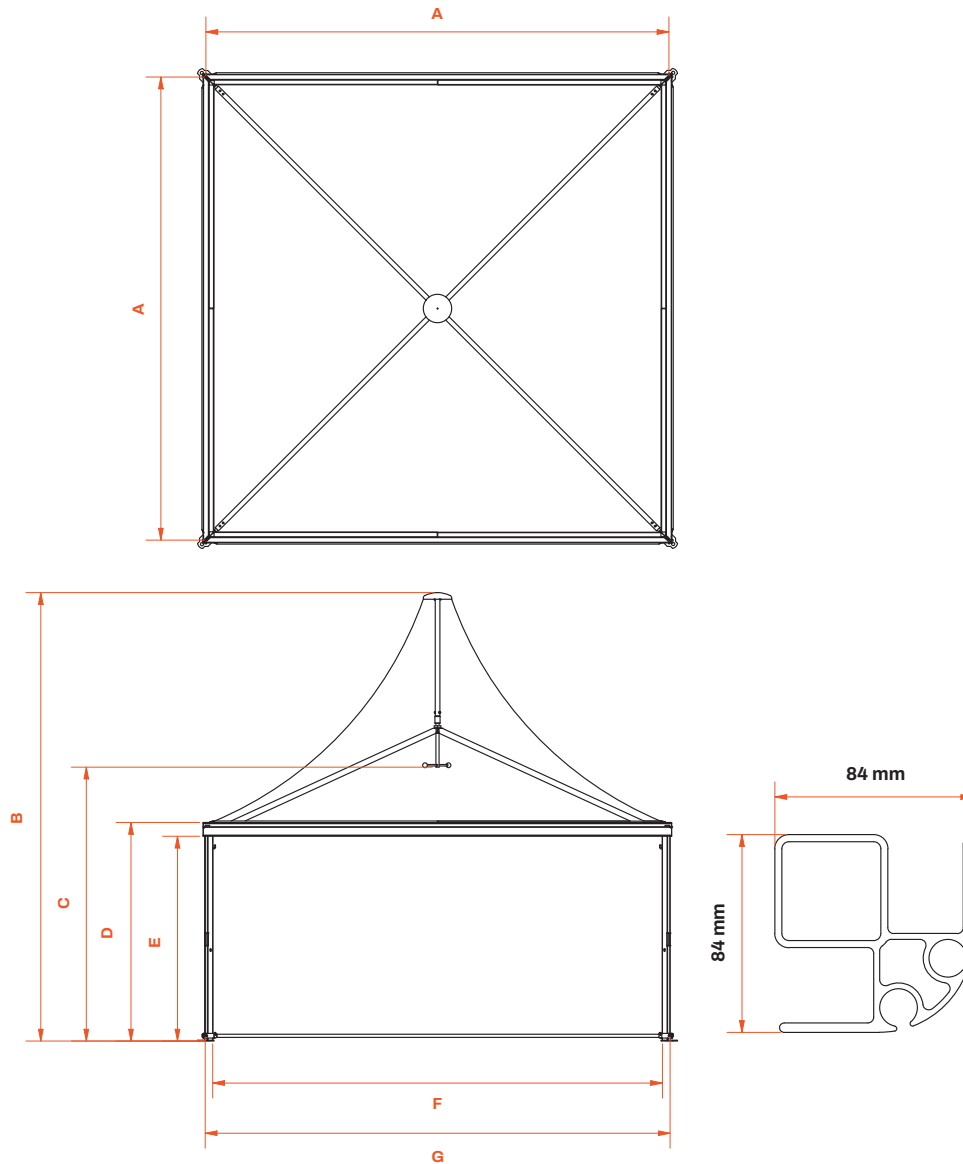

**TT84 serie | 3x3 m, 4x4 m, 5x5 m | Pagode**

	Constructie 3x3 meter	Constructie 4x4 meter	Constructie 5x5 meter
<b>A</b> Segment lengte h.o.h.	2.854 mm	3.854 mm	4.856 mm
<b>B</b> Nokhoogte, verstelbaar	4.075 - 4.375 mm	4.316 - 4.616 mm	4.737 - 5.037 mm
<b>C</b> Binnenhoogte, verstelbaar	2.350 - 2.650 mm	2.490 - 2.790 mm	3.010 - 3.310 mm
<b>D</b> Zijhoogte	2.321 mm	2.321 mm	2.321 mm
<b>E</b> Doorloophoogte	2.175 mm	2.175 mm	2.175 mm
<b>F</b> Binnenkant kolommen	2.770 mm	3.770 mm	4.772 mm
<b>G</b> Buitenkant kolommen	2.938 mm	3.938 mm	4.940 mm