



This sturdy pagoda tent is perfect if you would like hard walls or glass walls in the tent, but it can be fitted with PVC side panels as standard. In addition, the TT84 can easily be linked to other pagodas and alpine halls.

This pagoda is sturdy enough for a bar dispenser or attachment of a banner frame. This allows you to carry through the style and atmosphere of the event or festival to the marquee. The TT84 is available in sizes 3x3, 4x4 and 5x5 metres.



This tent type is **widely used** for:



Fairs and conferences



Events



Hospitality



Festivals



Weddings

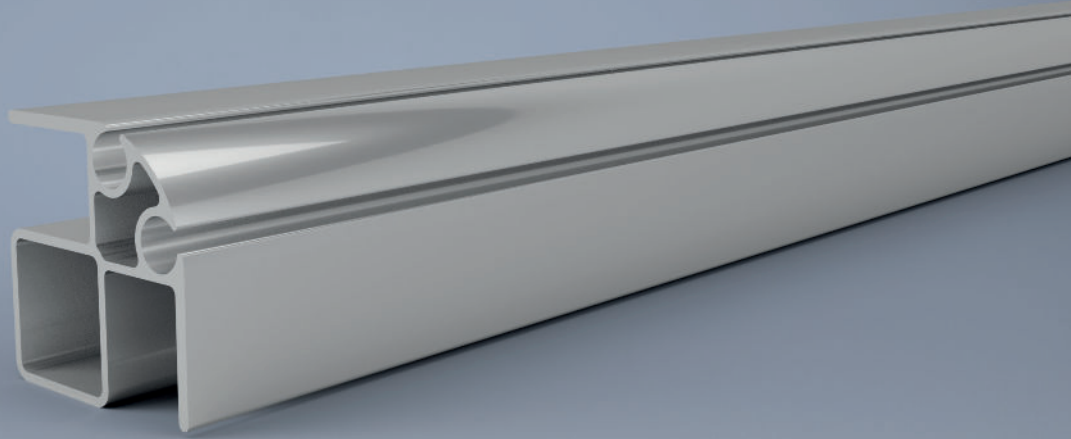

General specifications

Dimensions:	3.00 x 3.00 m 4.00 x 4.00 m 5.00 x 5.00 m
Side height:	2.30 m 3.00 m
Ridge height:	4.08 m - 5.04 m
Roof cladding:	Translucent PVC canvas Opaque (block-out) PVC canvas
Gable cladding:	Translucent PVC canvas Opaque (block-out) PVC canvas
Profile size:	84 x 84 mm
Maximum wind load:	On request
Maximum snow load:	On request
Aluminium:	AL6082 AL6005 Natural anodised Highly durable High corrosion resistance

Additional options:

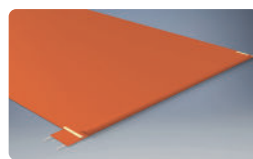

Coloured PVC canvas

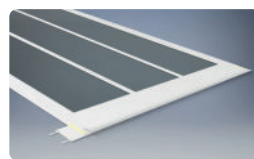

Transparent PVC canvas

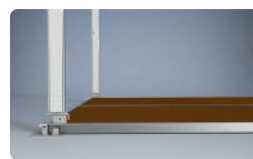

Heavy-duty flooring

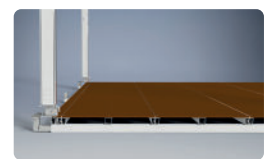

Cassette flooring



Transport rack



Solid wall panels



Glass wall panels



Single wicket door



Double wicket door glass



Coupling gutter between pagodas

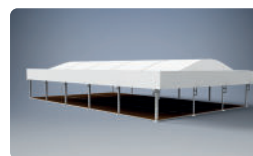

Banner frames



Bar dispenser

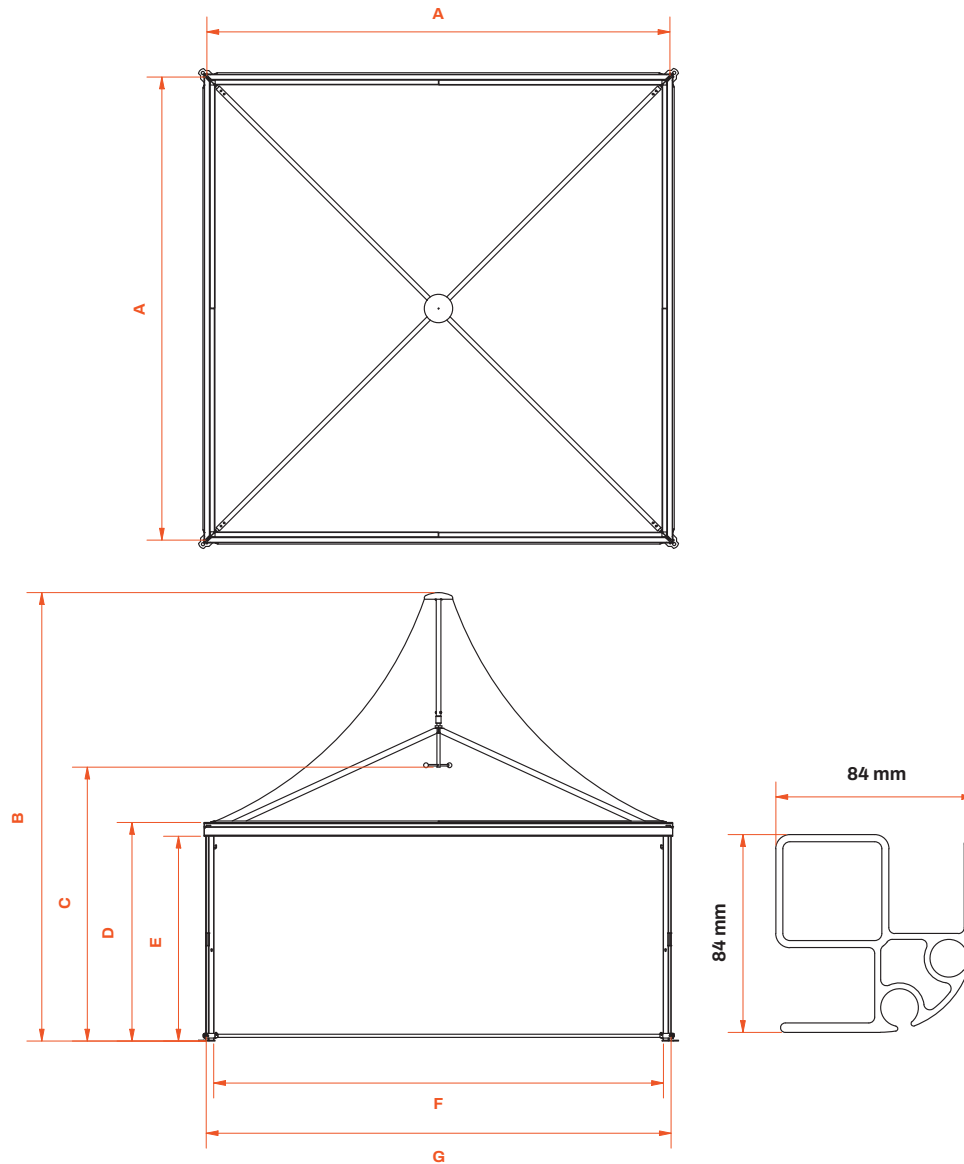

TT84 Series | 3x3 m, 4x4 m, 5x5 m | Pagoda

	Construction 3x3 metres	Construction 4x4 metres	Construction 5x5 metres
A Segment length c/c	2,854 mm	3,854 mm	4,856 mm
B Ridge height, adjustable	4,075 - 4,375 mm	4,316 - 4,616 mm	4,737 - 5,037 mm
C Inside height, adjustable	2,350 - 2,650 mm	2,490 - 2,790 mm	3,010 - 3,310 mm
D Side height	2,321 mm	2,321 mm	2,321 mm
E Passage height	2,175 mm	2,175 mm	2,175 mm
F Inside of columns	2,770 mm	3,770 mm	4,772 mm
G Outside of columns	2,938 mm	3,938 mm	4,940 mm